

Cadillac[®]

Cadillac Passenger Car and Utility Vehicle

**OWNERSHIP REGISTRATION CARD / National Sales Company's Copy**

Vehicle Ident. No. (VIN)	<input type="text"/>											
Model				Body Colour				Key Number				
Date of Delivery						Mileage at Delivery						
Owner's Name						Owner's Phone No.						
Owner's Address	Street											
	Post Code	City			Country							
Owner's Signature _____							Distributor Code _____					
							Distributor Name & Signature _____					
Remark							Distributor Stamp					



OWNERSHIP REGISTRATION CARD / Distributor Copy

Vehicle Ident. No. (VIN)	<input type="text"/>											
Model		Body Colour		Key Number								
Date of Delivery					Mileage at Delivery							
Owner's Name					Owner's Phone No.							
Owner's Address	Street											
	Post Code	City			Country							
Owner's Signature _____					Distributor Code _____							
					Distributor Name & Signature _____							
Remark					Distributor Stamp							



OWNERSHIP REGISTRATION CARD / Owner's Copy

Vehicle Ident. No. (VIN)	<input type="text"/>											
Model				Body Colour				Key Number				
Date of Delivery							Mileage at Delivery					
Owner's Name							Owner's Phone No.					
Owner's Address	Street											
	Post Code	City				Country						
Owner's Signature _____							Distributor Code _____					
							Distributor Name & Signature _____					
Remark							Distributor Stamp					



ODOMETER SERVICING RECORD

In case of odometer replacement, please complete the following information

<p>The odometer was replaced</p> <p>on (date) _____</p> <p>at (km/mile) _____</p> <p>by _____</p>	<p>Repairer's stamp</p>
<p>The odometer was replaced</p> <p>on (date) _____</p> <p>at (km/mile) _____</p> <p>by _____</p>	<p>Repairer's stamp</p>

Pre-Delivery Inspection and Vehicle Delivery

Before supplying the vehicle, we have carried out a pre-delivery inspection in order to ensure that your Cadillac is in a flawless state. The checklist from this pre-delivery inspection is supplied with the Service and Warranty Booklet completed. We have provided you with information on the service intervals, service tests, adverse operating conditions and engine oil changes in the owners manual.

Performed at _____ Date/KM/Miles _____

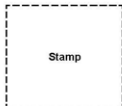

Authorised Repairer Name: _____

Signature: _____

Date: _____

Important Vehicle Data

Model:

Vehicle Identification Number:

Vehicle Registration Number:

Engine type, number:

Transmission:

Colour, code:

Interior, code:

First Registration:

Leave this coupon in the booklet

Leave this coupon in the booklet

2016 Cadillac Passenger Car and Utility Vehicle

Important Service Information	1	Summary of Warranties	6
General	1	General	6
Cadillac's Commitment to You	1	Corrosion (Rust-through) Warranty	6
Pre-Delivery Inspection	1	Paint Warranty	6
Vehicle Operation and Care	1	Vehicle Alteration	6
Periodic Inspection and Service	1	Production Changes	7
Maintenance Records	2	Owner's Responsibility	7
Travel Abroad	2	After Warranty Repairs	7
Odometer Servicing	2	Scheduled Maintenance	8
End-of-Life Vehicle Recovery	2	Regular Check-Up	8
New Vehicle Limited Warranty	3	Owner Assistance	28
Tyre Warranty	4	Two-Stage satisfaction procedure	28
Cadillac ELR V	4	Cadillac Assistance	31
What is covered	4		

General

This booklet contains warranty policies covering your new vehicle. Please refer to the Owners Manual for recommendations on regular maintenance schedule which is necessary to ensure that your vehicle gives you many years of trouble free driving.

Please read this booklet as well as the Owners Manual carefully, so as to familiarise yourself with the type of service which you are entitled to under each of the warranties applicable to your new vehicle.

Cadillac's Commitment to You

Our goal is to provide you with a superior ownership experience. We are committed to assuring your satisfaction with your new Cadillac.

We want you to be completely satisfied and invite you to return for all service needs, both during and after the warranty period.

Pre-Delivery Inspection

Defects in or damage to the mechanical, electrical, sheet metal, paint, trim, and other components of your vehicle may occur at the factory or while it is being transported to the distributor. Normally, any defect or damage occurring during assembly is detected and corrected at the factory during the inspection process. In addition, distributors are obligated to inspect each vehicle before delivery. They repair any uncorrected factory defects or damage and any transit damage detected before the vehicle is delivered to you.

Any defects still present at the time the vehicle is delivered to you are covered by the warranty. If you find any such defects when you take delivery, please advise your distributor without delay. For further details concerning any repairs which the distributor may have made prior to your taking delivery of your vehicle, please ask your distributor.

Vehicle Operation and Care

Always have your Cadillac serviced regularly. By doing this, you will ensure the continued efficiency of your vehicle.

It is recommended that you ask your Cadillac authorised repairer to carry out the service because they are equipped with special service tools, and have staff experienced in servicing Cadillac vehicles.

Periodic Inspection and Service

Regular inspection and maintenance by skilled technicians is the key to more efficient operation of the vehicle. The safety inspection and lubrication service should be performed as described in the owner's manual, to ensure optimum vehicle operation and performance.

2 Important Service Information

Maintenance Records

It is also recommended that receipts covering the performance of regular maintenance be retained. Damage to your vehicle caused by lack of maintenance is not covered by your warranties. Therefore, receipts can be very important if a question arises as to whether a failure is caused by lack of maintenance or a defect in material or workmanship.

Also, a Maintenance Record form is provided in this booklet for your convenience in recording service performed.

Travel Abroad

Your warranty cover extends to Europe and the warranty work can be carried out in the listed European countries. The warranty cover in Europe is the same as for the

country that the vehicle is sold. If your country is not listed below, please contact your country organisation for information when travelling abroad. If you travel within Europe, it is important that you take this booklet with the stamp and signature of the selling distributor as evidence that your car has warranty cover.

Countries: ALBANIA, AUSTRIA, BELGIUM, BOSNIA-HERZEGOVINA, BULGARIA, CROATIA, CYPRUS, CZECH REPUBLIC, DENMARK, ESTONIA, FINLAND, FRANCE, GERMANY, GREECE, HUNGARY, ICELAND, IRELAND, ITALY, LATVIA, LITHUANIA, LUXEMBOURG, MACEDONIA, MALTA, NETHERLANDS, NORWAY, POLAND, PORTUGAL, ROMANIA,

SERBIA-MONTENEGRO, SLOVAKIA, SLOVENIA, SPAIN, SWEDEN, SWITZERLAND, TURKEY, U.K.

Odometer Servicing

When an odometer is replaced, the relevant information such as repair date, running mileage and name of mechanic and Cadillac authorised repairer should be recorded by servicing authorised repairer.

End-of-Life Vehicle Recovery

Information regarding the recycling-compatible design, end-of-life vehicle recovery centres and recycling of end-of-life vehicles is available on the Internet at www.cadillac europe.com.

General Motors Overseas Distribution LLC (GMOD LLC) warranty to the owner of each Cadillac that your Cadillac shall be free, under normal use and maintenance, from any defects in material and workmanship, subject to the following terms and conditions.

1. **WARRANTY PERIOD**

The warranty period for all coverages begins on the date the vehicle is first delivered or put in use and ends at the expiration of the complete vehicle coverage or other special coverages shown below.

A. **Complete vehicle coverage**

The complete vehicle (except those items listed under "what is not covered") is covered for 36 months or 100,000 kms (60,000 miles) whichever comes first, but the mileage limit will not be applied for the initial 24 months.

B. **Corrosion (rust-through) coverage**

Any body sheet metal panel that rust-through due to corrosion is covered for 6 years regardless of mileage.

C. **Paint Coverage**

The initial paint finish is covered for 3 years, regardless of mileage.

2. **WHAT IS COVERED**

Except as provided in paragraphs 3 hereof, your Cadillac authorised repairer shall either repair or replace, at its option, any genuine part that is defective in material or workmanship within the warranty period set forth in paragraph 1 hereof, without charge to the owner of the vehicle.

3. **WHAT IS NOT COVERED**

This warranty shall not apply to or include any of the following.

- A. Repair or replacement required not as a result in material or workmanship of Manufacturer but as a result of (i) accident, (ii) misuse, (iii) lack of proper maintenance, (iv) repairs improperly performed or replacements improperly installed by any person other than a Cadillac authorised repairer, (v) a replacement part or accessory not conforming to the Manufacturer's specifications, (vi) usage of any fuel other than that specified for your Cadillac, (vii) alterations by changing or adding to the vehicle, or (viii) damage from environmental conditions such as airborne fallout, salt, hail, windstorm, lightning, flood and the like.

4 New Vehicle Limited Warranty

- B. Any Cadillac vehicle equipment subject to normal wear and tear, including, without limitation, filters, ignition points and condensers, spark plugs, drive belt(s), fuses, clutch facing, brake linings, wiper blades, and the like.
- C. Normal maintenance service, including, without limitation, cleaning and polishing, lubrication, adding coolant, and engine tune-up.
- D. Any Cadillac vehicle on which the odometer mileage has been altered or on which the actual mileage of the vehicle cannot be readily determined.
- E. Extra expenses including, without limitation, payment for loss of the use of the vehicle, lodging bills, vehicle rentals, other travel costs and loss of pay.

Tyre Warranty

Tyres installed as original equipment on Cadillac vehicles are covered by warranties by their respective manufacturers and not by warranties by GMOD LLC.

Cadillac ELR V

In addition to the European Bumper-to-Bumper Warranty Coverage, General Motors Overseas Distribution LLC will warrant certain ELR V components for each ELR V for 8 years or 160 000 kilometres (100,000 miles), whichever comes first, from the original in-service date of the vehicle, against warrantable repairs to the specific ELR V components of the vehicle.

This warranty is for ELR V vehicles registered in Europe and normally operated in Europe. In addition to the initial owner of the vehicle, the coverage described in this ELR V warranty is transferable at no cost to any subsequent person(s) who assumes ownership of the vehicle within the above-described 8 years or 160,000 kilometres

(100,000 miles) term. No deductibles are associated with this ELR V warranty.

This ELR V warranty is in addition to the express conditions and warranties described previously. The coverage and benefits described under "New Vehicle Limited Warranty" are not extended or altered because of this special ELR V Component Warranty.

What is covered

This ELR V warranty covers repairs to correct any vehicle defect related to materials or workmanship occurring during the 8 year or 160 000 kilometres (100,000 miles) term for the following:

Transmission

The ELR V transmission assembly and internal components, including the transmission auxiliary fluid pump, transmission auxiliary pump controller and 3-phase transmission cables

Brakes

Brake Modulator Assembly

Other ELR V Components

ELR V Battery The 300-volt electrical system includes:

- ELR V High Voltage Wiring
- ELR V High Voltage Wiring
- Transmission Power Inverter Module (TPIM)
- Accessory Power Module (APM)

What Is not covered

In addition to the “What is not covered” section previously, this ELR V warranty does not cover the following items:

Wear Items

Wear items, such as brake linings, are not covered in this ELR V warranty.

6 Summary of Warranties

General

It is our intent to repair under warranty, without charge, anything that goes wrong during the warranty period that is the fault of the manufacturer.

Please note the distinction between “defects” and “damage” as used in the warranty: defects are covered because the manufacturer is responsible; on the other hand, we have no control over damage caused by such things as collision, misuse and lack of maintenance which occurs after the vehicle is delivered to you. Therefore, damage for any reason which occurs after the vehicle is delivered to you is not covered under the warranty.

Maintenance services also are excluded from the warranty because it is the owner's responsibility to maintain their own vehicle in accordance with the Maintenance Schedule.

Corrosion (Rust-through) Warranty

The corrosion warranty applies to perforation due to corrosion only for six years regardless of mileage.

Perforation means a Rust-Through condition, such as an actual hole in a sheet metal panel. Cosmetic or surface corrosion (resulting from stone chips or scratches in the paint, for example) would not be repaired under this coverage. This warranty specifically excludes any defect to the exhaust system of the vehicles. This warranty will remain effective, provided the following conditions are observed.

The vehicle owner must ensure that;

- The corrosion inspection protection specified in this booklet is performed by a Cadillac authorised repairer.
- Any claim under this warranty is supported by evidence that the annual body inspection has been carried out. The inspection must be recorded at the time it is carried out, by the Cadillac

authorised repairer, by completing the section provided in this booklet.

- Paintwork deterioration or damage to the body protection of the vehicle that is reported by the Cadillac authorised repairer to the vehicle owner is promptly rectified at the owner's expense by a Cadillac authorised repairer.

Paint Warranty

This warranty covers any paint defect occurring under normal use and due to defects in material or workmanship for three years regardless of mileage.

Vehicle Alteration

This warranty does not cover alteration of the vehicle, or failures of vehicle components caused by such alteration. Examples of the types of alteration that would not be covered include, but are not limited to, after-manufacture rustproofing or the installation of accessories (Except those approved and

developed by Cadillac) such as sun roofs, trailer hitches and air conditioning systems.

Production Changes

Cadillac reserves the right to make changes in vehicles built and/or sold at any time without incurring any obligation to make the same or similar changes on vehicles previously built or sold.

Owner's Responsibility

Maintenance services are the owner's responsibility. You should retain evidence that proper maintenance has been performed on your Cadillac. **Claims made during the warranty period will not qualify under the warranty if resulting from lack of maintenance rather than from defective material or workmanship.** We recommend that such services be performed by a Cadillac authorised repairer using genuine parts. Please note that the maintenance service described in the Owner's Manual should be performed even more frequently if

your vehicle is subject to severe conditions such as operation in extremely dusty or extreme (high or low) temperature areas. Under such severe conditions, we recommend that your engine oil level be checked each time you purchase fuel for your Cadillac and that your engine coolant and cooling fan belt be inspected frequently. Refer to the Owner's Manual for applicable specification.

After Warranty Repairs

If you have a problem with your vehicle after warranty coverage has expired, we urge you to continue to return to your Cadillac authorised repairer for routine maintenance, problem diagnosis and repairs. Your authorised repairers know your vehicle best and are interested in your continued satisfaction.

8 Scheduled Maintenance

Regular maintenance is a major factor in ensuring long vehicle life, sustained performance and trouble-free running. To help achieve this, Cadillac has developed a plan of inspection and service operations to be carried out at intervals. It is very important that your vehicle is serviced at the correct intervals as described in your Owner's Manual.

The annual service is carried out at intervals of not more than 12 months, even on low mileage vehicles.

Periodically, as the time and mileage increase, your Cadillac authorised repairer will automatically undertake the additional work shown on the table.

It is strongly recommended that the maintenance services are performed by a Cadillac authorised repairer which has factory trained technicians and genuine parts to service your vehicle properly.

Inadequate, incomplete, or insufficient servicing may result in operational problems with your

vehicle that could lead to vehicle damage, an accident, or personal injury.

Regular Check-Up

The following checks should be regularly carried out by the vehicle owner to maintain safe and dependable operation.

CHECK

- Engine oil level
- Brake and clutch fluid level
- Power steering fluid level
- Windscreen washer fluid level
- Battery condition
- Operation of lights
- Fuel level
- All switches
- Operation of parking brake
- Rear view mirrors
- Coolant level
- Tyre condition (especially if a vehicle is operated under bad road condition)

10 Scheduled Maintenance

MAINTENANCE RECORD

<p>1st MAINTENANCE RECORD</p> <p>Date: _____</p> <p>km/miles _____</p> <p>Oil specification _____</p> <p>Work Order No. _____</p> <p>Signature of Authorised Repairer representative _____</p> <p>Authorised Repairer's Stamp _____</p> <p>Next service: Date km/miles</p>	<p>2nd MAINTENANCE RECORD</p> <p>Date: _____</p> <p>km/miles _____</p> <p>Oil specification _____</p> <p>Work Order No. _____</p> <p>Signature of Authorised Repairer representative _____</p> <p>Authorised Repairer's Stamp _____</p> <p>Next service: Date km/miles</p>	<p>3rd MAINTENANCE RECORD</p> <p>Date: _____</p> <p>km/miles _____</p> <p>Oil specification _____</p> <p>Work Order No. _____</p> <p>Signature of Authorised Repairer representative _____</p> <p>Authorised Repairer's Stamp _____</p> <p>Next service: Date km/miles</p>
<p>4th MAINTENANCE RECORD</p> <p>Date: _____</p> <p>km/miles _____</p> <p>Oil specification _____</p> <p>Work Order No. _____</p> <p>Signature of Authorised Repairer representative _____</p> <p>Authorised Repairer's Stamp _____</p> <p>Next service: Date km/miles</p>	<p>5th MAINTENANCE RECORD</p> <p>Date: _____</p> <p>km/miles _____</p> <p>Oil specification _____</p> <p>Work Order No. _____</p> <p>Signature of Authorised Repairer representative _____</p> <p>Authorised Repairer's Stamp _____</p> <p>Next service: Date km/miles</p>	<p>6th MAINTENANCE RECORD</p> <p>Date: _____</p> <p>km/miles _____</p> <p>Oil specification _____</p> <p>Work Order No. _____</p> <p>Signature of Authorised Repairer representative _____</p> <p>Authorised Repairer's Stamp _____</p> <p>Next service: Date km/miles</p>

MAINTENANCE RECORD

<p>7th MAINTENANCE RECORD</p> <p>Date: _____</p> <p>km/miles _____</p> <p>Oil specification _____</p> <p>Work Order No. _____</p> <p>Signature of Authorised Repairer representative _____</p> <div style="border: 1px solid black; padding: 5px; text-align: center; margin: 5px 0;"> Authorised Repairer's Stamp </div> <p>Next service: Date km/miles</p>	<p>8th MAINTENANCE RECORD</p> <p>Date: _____</p> <p>km/miles _____</p> <p>Oil specification _____</p> <p>Work Order No. _____</p> <p>Signature of Authorised Repairer representative _____</p> <div style="border: 1px solid black; padding: 5px; text-align: center; margin: 5px 0;"> Authorised Repairer's Stamp </div> <p>Next service: Date km/miles</p>	<p>9th MAINTENANCE RECORD</p> <p>Date: _____</p> <p>km/miles _____</p> <p>Oil specification _____</p> <p>Work Order No. _____</p> <p>Signature of Authorised Repairer representative _____</p> <div style="border: 1px solid black; padding: 5px; text-align: center; margin: 5px 0;"> Authorised Repairer's Stamp </div> <p>Next service: Date km/miles</p>
<p>10th MAINTENANCE RECORD</p> <p>Date: _____</p> <p>km/miles _____</p> <p>Oil specification _____</p> <p>Work Order No. _____</p> <p>Signature of Authorised Repairer representative _____</p> <div style="border: 1px solid black; padding: 5px; text-align: center; margin: 5px 0;"> Authorised Repairer's Stamp </div> <p>Next service: Date km/miles</p>	<p>11th MAINTENANCE RECORD</p> <p>Date: _____</p> <p>km/miles _____</p> <p>Oil specification _____</p> <p>Work Order No. _____</p> <p>Signature of Authorised Repairer representative _____</p> <div style="border: 1px solid black; padding: 5px; text-align: center; margin: 5px 0;"> Authorised Repairer's Stamp </div> <p>Next service: Date km/miles</p>	<p>12th MAINTENANCE RECORD</p> <p>Date: _____</p> <p>km/miles _____</p> <p>Oil specification _____</p> <p>Work Order No. _____</p> <p>Signature of Authorised Repairer representative _____</p> <div style="border: 1px solid black; padding: 5px; text-align: center; margin: 5px 0;"> Authorised Repairer's Stamp </div> <p>Next service: Date km/miles</p>

ADDITIONAL MAINTENANCE RECORD
(SERVICE RECORD OF ENGINE OIL AND FILTER CHANGE)

<p style="text-align: center;">ENGINE OIL AND FILTER CHANGE</p> <hr/> <p>Date: _____</p> <p>km/mile _____</p> <p>Oil viscosity ____W- ____</p> <hr/> <p>Signature of Authorised Repairer representative</p> <hr/> <p style="text-align: center;">Authorised Repairer's Stamp</p>	<p style="text-align: center;">ENGINE OIL AND FILTER CHANGE</p> <hr/> <p>Date: _____</p> <p>km/mile _____</p> <p>Oil viscosity ____W- ____</p> <hr/> <p>Signature of Authorised Repairer representative</p> <hr/> <p style="text-align: center;">Authorised Repairer's Stamp</p>	<p style="text-align: center;">ENGINE OIL AND FILTER CHANGE</p> <hr/> <p>Date: _____</p> <p>km/mile _____</p> <p>Oil viscosity ____W- ____</p> <hr/> <p>Signature of Authorised Repairer representative</p> <hr/> <p style="text-align: center;">Authorised Repairer's Stamp</p>
<p style="text-align: center;">ENGINE OIL AND FILTER CHANGE</p> <hr/> <p>Date: _____</p> <p>km/mile _____</p> <p>Oil viscosity ____W- ____</p> <hr/> <p>Signature of Authorised Repairer representative</p> <hr/> <p style="text-align: center;">Authorised Repairer's Stamp</p>	<p style="text-align: center;">ENGINE OIL AND FILTER CHANGE</p> <hr/> <p>Date: _____</p> <p>km/mile _____</p> <p>Oil viscosity ____W- ____</p> <hr/> <p>Signature of Authorised Repairer representative</p> <hr/> <p style="text-align: center;">Authorised Repairer's Stamp</p>	<p style="text-align: center;">ENGINE OIL AND FILTER CHANGE</p> <hr/> <p>Date: _____</p> <p>km/mile _____</p> <p>Oil viscosity ____W- ____</p> <hr/> <p>Signature of Authorised Repairer representative</p> <hr/> <p style="text-align: center;">Authorised Repairer's Stamp</p>

14 Scheduled Maintenance

ADDITIONAL RECORDS

<p>Number: _____</p> <p>Date: _____</p> <p>km/mile _____</p> <p>_____</p> <p>Signature of Authorised Repairer representative</p> <p>Authorised Repairer's Stamp</p>	<p>Number: _____</p> <p>Date: _____</p> <p>km/mile _____</p> <p>_____</p> <p>Signature of Authorised Repairer representative</p> <p>Authorised Repairer's Stamp</p>	<p>Number: _____</p> <p>Date: _____</p> <p>km/mile _____</p> <p>_____</p> <p>Signature of Authorised Repairer representative</p> <p>Authorised Repairer's Stamp</p>
<p>Number: _____</p> <p>Date: _____</p> <p>km/mile _____</p> <p>_____</p> <p>Signature of Authorised Repairer representative</p> <p>Authorised Repairer's Stamp</p>	<p>Number: _____</p> <p>Date: _____</p> <p>km/mile _____</p> <p>_____</p> <p>Signature of Authorised Repairer representative</p> <p>Authorised Repairer's Stamp</p>	<p>Number: _____</p> <p>Date: _____</p> <p>km/mile _____</p> <p>_____</p> <p>Signature of Authorised Repairer representative</p> <p>Authorised Repairer's Stamp</p>

<p>Number: _____</p> <p>Date: _____</p> <p>km/mile _____</p> <p>_____</p> <p>Signature of Authorised Repairer representative</p> <p>Authorised Repairer's Stamp</p>	<p>Number: _____</p> <p>Date: _____</p> <p>km/mile _____</p> <p>_____</p> <p>Signature of Authorised Repairer representative</p> <p>Authorised Repairer's Stamp</p>	<p>Number: _____</p> <p>Date: _____</p> <p>km/mile _____</p> <p>_____</p> <p>Signature of Authorised Repairer representative</p> <p>Authorised Repairer's Stamp</p>
<p>Number: _____</p> <p>Date: _____</p> <p>km/mile _____</p> <p>_____</p> <p>Signature of Authorised Repairer representative</p> <p>Authorised Repairer's Stamp</p>	<p>Number: _____</p> <p>Date: _____</p> <p>km/mile _____</p> <p>_____</p> <p>Signature of Authorised Repairer representative</p> <p>Authorised Repairer's Stamp</p>	<p>Number: _____</p> <p>Date: _____</p> <p>km/mile _____</p> <p>_____</p> <p>Signature of Authorised Repairer representative</p> <p>Authorised Repairer's Stamp</p>

16 Scheduled Maintenance

1. ANNUAL INSPECTION: BODY AND PAINT

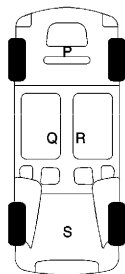
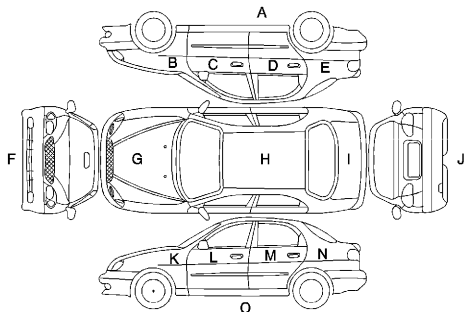

Body:	yes	no
Damaged	()	()
Stone Chipping	()	()
Dent	()	()
Scratch	()	()
Underbody protection*:		
Damaged	()	()
Repaired	()	()

Damage repaired yes: () no: ()
 Comments yes: () no: ()

Repair contract / Invoice Number

Workshop Stamp

 Date / Signature

NOTE: According to Cadillac Repair regulations (or repair terms) Identified damage must be repaired immediately to keep the 6 year guarantee against rust valid.

2. ANNUAL INSPECTION: BODY AND PAINT

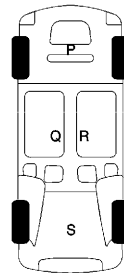
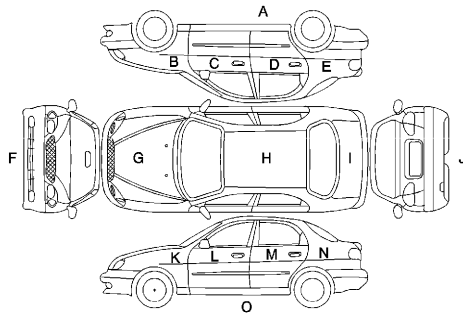

Body:	yes	no
Damaged	()	()
Stone Chipping	()	()
Dent	()	()
Scratch	()	()
Underbody protection*:		
Damaged	()	()
Repaired	()	()

Damage repaired yes: () no: ()

Comments yes: () no: ()

Repair contract / Invoice Number

Workshop Stamp

Date / Signature

NOTE: According to Cadillac Repair regulations (or repair terms) Identified damage must be repaired immediately to keep the 6 year guarantee against rust valid.

18 Scheduled Maintenance

3. ANNUAL INSPECTION: BODY AND PAINT

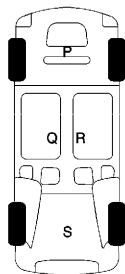
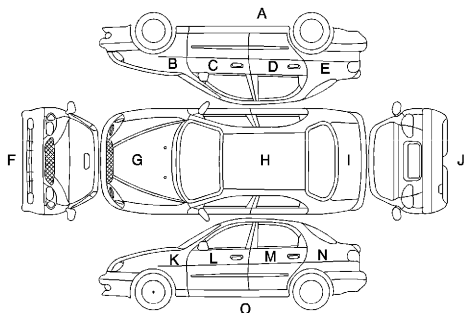

Body:	yes	no
Damaged	()	()
Stone Chipping	()	()
Dent	()	()
Scratch	()	()
Underbody protection*:		
Damaged	()	()
Repaired	()	()

Damage repaired yes: () no: ()
 Comments yes: () no: ()

Repair contract / Invoice Number

Workshop Stamp

Date / Signature

NOTE: According to Cadillac Repair regulations (or repair terms) Identified damage must be repaired immediately to keep the 6 year guarantee against rust valid.

4. ANNUAL INSPECTION: BODY AND PAINT

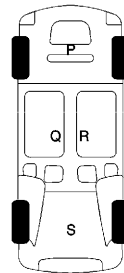
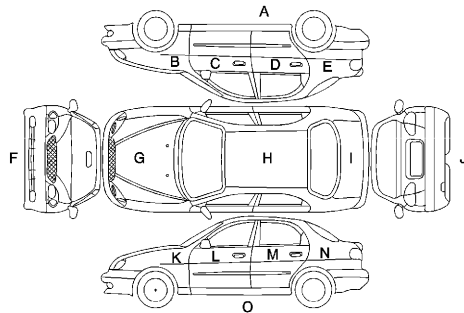

Body:	yes	no
Damaged	()	()
Stone Chipping	()	()
Dent	()	()
Scratch	()	()
Underbody protection*:		
Damaged	()	()
Repaired	()	()

Damage repaired yes: () no: ()
 Comments yes: () no: ()

Repair contract / Invoice Number

Workshop Stamp

Date / Signature

NOTE: According to Cadillac Repair regulations (or repair terms) Identified damage must be repaired immediately to keep the 6 year guarantee against rust valid.

20 Scheduled Maintenance

5. ANNUAL INSPECTION: BODY AND PAINT

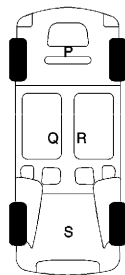
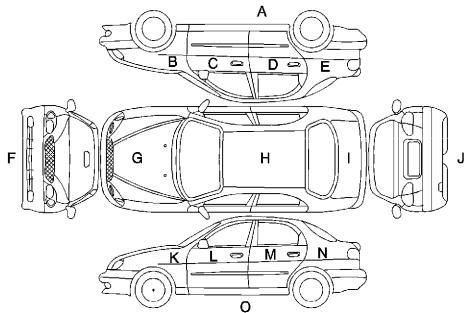

Body:	yes	no
Damaged	()	()
Stone Chipping	()	()
Dent	()	()
Scratch	()	()
Underbody protection*:		
Damaged	()	()
Repaired	()	()

Damage repaired yes: () no: ()

Comments yes: () no: ()

Repair contract / Invoice Number

Workshop Stamp

Date / Signature

NOTE: According to Cadillac Repair regulations (or repair terms) Identified damage must be repaired immediately to keep the 6 year guarantee against rust valid.

6. ANNUAL INSPECTION: BODY AND PAINT

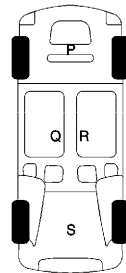
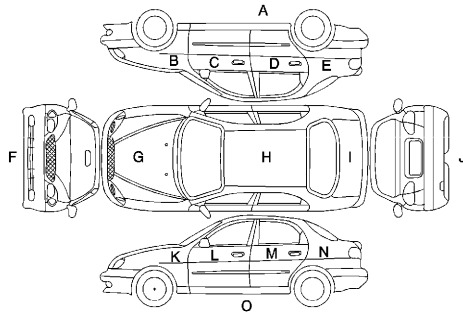

Body:	yes	no
Damaged	()	()
Stone Chipping	()	()
Dent	()	()
Scratch	()	()
Underbody protection*:		
Damaged	()	()
Repaired	()	()

Damage repaired yes: () no: ()

Comments yes: () no: ()

Repair contract / Invoice Number

Workshop Stamp

Date / Signature

NOTE: According to Cadillac Repair regulations (or repair terms) Identified damage must be repaired immediately to keep the 6 year guarantee against rust valid.

22 Scheduled Maintenance

7. ANNUAL INSPECTION: BODY AND PAINT

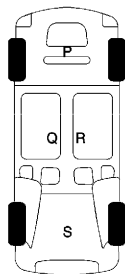
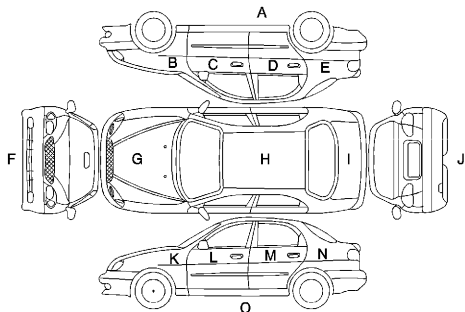

Body:	yes	no
Damaged	()	()
Stone Chipping	()	()
Dent	()	()
Scratch	()	()
Underbody protection*:		
Damaged	()	()
Repaired	()	()

Damage repaired yes: () no: ()
 Comments yes: () no: ()

Repair contract / Invoice Number

Workshop Stamp

 Date / Signature

NOTE: According to Cadillac Repair regulations (or repair terms) Identified damage must be repaired immediately to keep the 6 year guarantee against rust valid.

8. ANNUAL INSPECTION: BODY AND PAINT

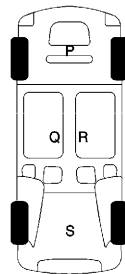
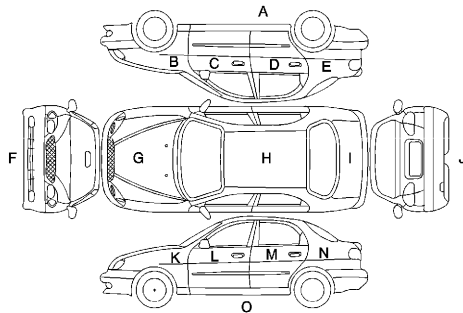

Body:	yes	no
Damaged	()	()
Stone Chipping	()	()
Dent	()	()
Scratch	()	()
Underbody protection*:		
Damaged	()	()
Repaired	()	()

Damage repaired yes: () no: ()

Comments yes: () no: ()

Repair contract / Invoice Number

Workshop Stamp

Date / Signature

NOTE: According to Cadillac Repair regulations (or repair terms) Identified damage must be repaired immediately to keep the 6 year guarantee against rust valid.

24 Scheduled Maintenance

9. ANNUAL INSPECTION: BODY AND PAINT

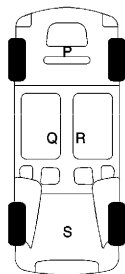
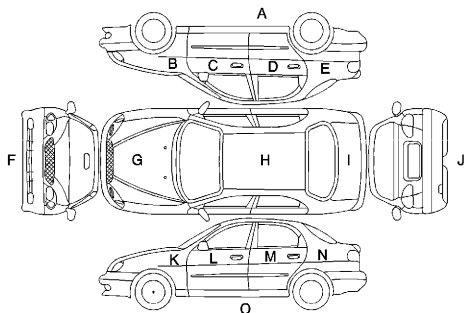

Body:	yes	no
Damaged	()	()
Stone Chipping	()	()
Dent	()	()
Scratch	()	()
Underbody protection*:		
Damaged	()	()
Repaired	()	()

Damage repaired yes: () no: ()
 Comments yes: () no: ()

Repair contract / Invoice Number

Workshop Stamp

 Date / Signature

NOTE: According to Cadillac Repair regulations (or repair terms) Identified damage must be repaired immediately to keep the 6 year guarantee against rust valid.

10. ANNUAL INSPECTION: BODY AND PAINT

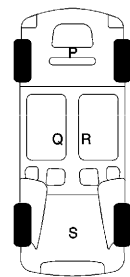
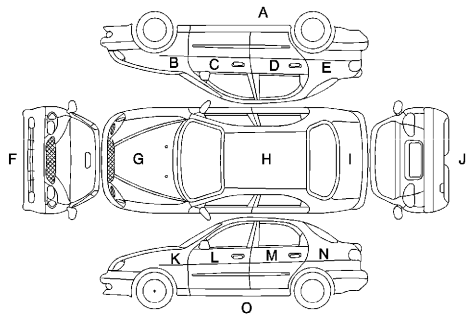

Body:	yes	no
Damaged	()	()
Stone Chipping	()	()
Dent	()	()
Scratch	()	()
Underbody protection*:		
Damaged	()	()
Repaired	()	()

Damage repaired yes: () no: ()
 Comments yes: () no: ()

Repair contract / Invoice Number

Workshop Stamp

Date / Signature

NOTE: According to Cadillac Repair regulations (or repair terms) Identified damage must be repaired immediately to keep the 6 year guarantee against rust valid.

26 Scheduled Maintenance

11. ANNUAL INSPECTION: BODY AND PAINT

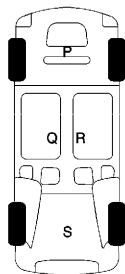
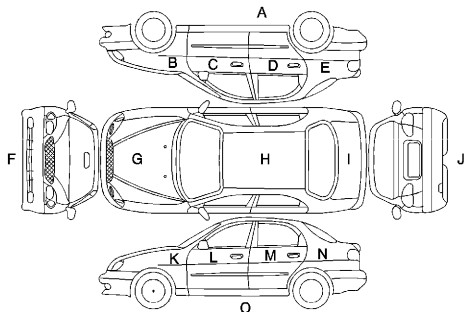

Body:	yes	no
Damaged	()	()
Stone Chipping	()	()
Dent	()	()
Scratch	()	()
Underbody protection*:		
Damaged	()	()
Repaired	()	()

Damage repaired yes: () no: ()
 Comments yes: () no: ()

Repair contract / Invoice Number

Workshop Stamp

 Date / Signature

NOTE: According to Cadillac Repair regulations (or repair terms) Identified damage must be repaired immediately to keep the 6 year guarantee against rust valid.

12. ANNUAL INSPECTION: BODY AND PAINT

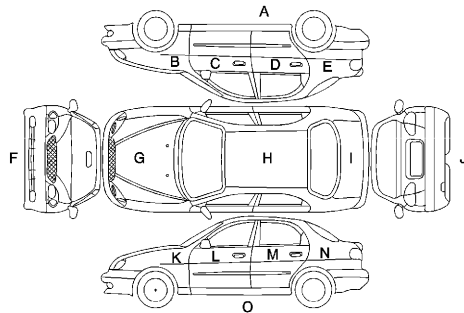

Body:	yes	no
Damaged	()	()
Stone Chipping	()	()
Dent	()	()
Scratch	()	()
Underbody protection*:		
Damaged	()	()
Repaired	()	()

Damage repaired yes: () no: ()
 Comments yes: () no: ()

Repair contract / Invoice Number

Workshop Stamp

Date / Signature

NOTE: According to Cadillac Repair regulations (or repair terms) Identified damage must be repaired immediately to keep the 6 year guarantee against rust valid.

Two-Stage satisfaction procedure

Your satisfaction and goodwill are important to your dealer and to Cadillac. Normally, any concerns with the sales transaction or the operation of your vehicle will be resolved by your dealer's sales or service departments. Sometimes, however, despite the best intentions of all involved, misunderstandings can occur. If your concern has not been resolved to your satisfaction, the following steps should be taken:

One – Discuss your concern with a member of the dealer or service centre management. Concerns can often be quickly resolved at that level. If the concern has already been reviewed with the sales or service manager, contact the owner of the dealership or the general manager.

Two – If your concern cannot be resolved quickly by the dealer or service centre management, – contact the Cadillac Customer Assistance Centre.

Mailing Address:

Cadillac Customer Assistance
Centre
P.O. Box 196
12724 Skarholmen
Sweden
cadillac.europe@gm.com

Country	Local Phone Number	International Phone Number
Austria	0800 068890	0043800068890
Belgium	080058021	003280058021
Bosnia and Herzegovina	(033)-282 102	+387-33-282-102
Bulgaria	N/A	0044 2076601503
Croatia	N/A	0044 2076601503
Cyprus	N/A	0044 2076601503
Czech Republic	800720066	00420800720066
Denmark	80400123	004580400123
Estonia	N/A	0044 2076601503
Finland	N/A	0044 2076601503
France (+Corsica)	0805980246	0033805980246
Germany	08006270977	00498006270977
Greece	080033154416	0080033154416
Italy (+Sicily/Sardinia/San Marino/ Vatican City)	800597495	0039800597495
Latvia	N/A	0044 2076601503
Lithuania	N/A	0044 2076601503
Luxembourg	8004 0032	003528004 0032
Malta	N/A	0044 2076601503

Country	Local Phone Number	International Phone Number
Netherlands	08000205902	00318000205902
Norway	N/A	0044 2076601503
Poland	N/A	0044 2076601503
Romania	N/A	0044 2076601503
Slovakia	N/A	0044 2076601503
Slovenia	N/A	0044 2076601503
Spain	0800000158	0034800000158
Sweden	0201203247	0046201203247
Switzerland (+Liechtenstein)	0800199129	0041800199129
U.K.	08000260062	00448000260062

You should be prepared to provide the following information:

- Your name, address and telephone number.
- The identification number of your vehicle (This can be found in the registration papers, the inside front cover of this booklet, or on the plate attached to the top of the instrument panel visible through the windscreen.)

- The name and address of the dealer.
- The delivery date and present mileage of your vehicle.
- Details of your concern or request.

When contacting the Customer Assistance Centre, please bear in mind that your concern or request for assistance will most likely be resolved at the authorised repairer,

using the authorised repairer's facilities, equipment and personnel. This is why we suggest that you follow the previously mentioned steps in sequence whenever you need assistance.

Cadillac Assistance

Cadillac Assistance operates in conjunction with ARC EUROPE, the largest association of motoring clubs in Europe. It is designed to provide assistance to Cadillac owners with a wide range of services 24 hours a day, 365 days a year, throughout Europe.

These services are available for a period of 36 consecutive months, beginning with the initial "In Service Date" of each eligible vehicle.

Should any of these services be required, please contact the motoring club in the country you require assistance using the telephone number of the country where assistance is required, or the International telephone number. The call should be made immediately, before any other intervention is attempted.

Definitions

Authorised Repairer

Shall mean the network of authorised **Cadillac** repairers.

Beneficiary

Shall mean any individual who is entitled to receive Mobility Services within the terms and conditions set out in this contract through his/her authorised use of the Vehicle.

Accident

Shall mean an event that occurs when the vehicle collides with another vehicle, pedestrian, animal, road debris, or other geographical or architectural obstacle having a direct and sudden impact on the vehicle and resulting in the immediate immobilization of the vehicle.

Breakdown

Shall mean any sudden and unexpected failure of the vehicle caused by original mechanical or electrical equipment breakdown or failure leading to the immediate immobilization of the vehicle.

This includes incidents such as the unforeseen leakage of fuel, tyre punctures, broken keys, battery failure (e.g., radio not switched off)

of self-inflicted breakdowns such as lost or locked-in keys or running out of fuel.

Defects of a trailer shall not be considered a breakdown.

Accidents, fire not caused by vehicle components, and theft shall not be considered a breakdown.

In Service Date

The date at which the vehicle is delivered to the beneficiary for the first time and as recorded on the certificate completed and validated by the selling **Cadillac** dealer.

Immobilization

Shall mean that following a breakdown, accident, vandalism, or theft, either the vehicle is not operational at home or on roads accessible to the ARC service provider, so that the journey cannot be started or continued with the vehicle, or that the vehicle cannot be driven under safe conditions as required by law.

Period of Coverage

Shall mean the period of three years during which the beneficiary is entitled to receive the mobility services, starting from the first in service date.

Self-Inflicted Breakdown

Shall mean a non-technical failure of the vehicle resulting in the immediate immobilization of the vehicle.

Trailers

Vehicles without an engine, especially conceived and licensed for transporting persons or goods being pulled by the beneficiary vehicle complying, at the moment of the incident, with all local specific regulations.

Vehicle

Shall mean all **Cadillac** motor vehicles sold through the official **Cadillac** European Distribution

Networks reported to **ARC**, which comply with the following specifications:

- A. Maximum 9 seats
- B. Maximum width: 2.5 metres
- C. Maximum length: 16 metres (including any associated trailer)
- D. Maximum height: 3.2 metres
- E. Maximum gross weight: 3500 kgs

Terms and Conditions

1. Area of Coverage

The area of coverage comprises the following specific countries. All other countries are excluded.

Andorra, Austria, Belgium, Bosnia Herzegovina, Bulgaria, Croatia, Cyprus, Czech Republic, Denmark, Estonia, Finland, France, Germany, Greece, Hungary, Iceland,

Ireland, Italy, Latvia, Liechtenstein, Lithuania, Luxembourg, Macedonia, Malta, Monaco, the Netherlands, Norway, Poland, Portugal, Romania, San Marino, Serbia, Montenegro, Slovakia, Slovenia, Spain, Sweden, Switzerland, Turkey, United Kingdom.

2. Period of Coverage

The duration of coverage is for three years, starting with the first in service date.

3. Vehicles under Coverage

Under coverage are all vehicles sold through an authorised European Cadillac dealer. Rental vehicles, vehicles used by driving schools (during commercial use) and taxis are only eligible for Roadside Assistance and Towing.

4. **Beneficiary**

Beneficiaries are all authorised drivers and all passengers up to the maximum included in the manufacturer's vehicle specification. Hitchhikers are excluded.

5. **Exclusions**

Cover shall not extend to incidents:

- Caused by acts of God, war risks, strikes, seizures, constraint by government authorities, official interdiction, explosions of devices or nuclear or radioactive effects,
- Arising during the participation in motor sport events and any relation training,
- Causing cargo damage or loss of revenue,
- Causing trailer damage,

- Caused by a spare part or accessory installed in the vehicle, but not authorised by the Authorised Cadillac dealer.
- Caused following the failure to perform the required maintenance.
- Arising while operated by an authorised driver or a driver without a driving licence.

6. **Method of Rendering Services**

The beneficiary must contact Roadside Assistance using the contact telephone number listed. If the beneficiary did not call the Assistance Centre for authorisation prior to any intervention, assistance may be refused. Services must be authorised by the Assistance Centre before implementation.

7. **Roadside Assistance**

Attendance on the spot in case of breakdown will be organised. Roadside repair will be attempted in all cases except where this would go against local regulations (e.g. some highways).

Service will be given on roads open to public traffic and at home. Additionally service will be provided off-road for "all-terrain/off-road" models where access is possible and is permissible by law.

Service will also be given in following cases: failure of seat belts, broken windscreen wipers, malfunction of legally required external lights.

This benefit will not include salvage operations.

8. **Towage**

After breakdown of the vehicle, where roadside repair is not possible, professional towage of the vehicle with or without trailer to the nearest Authorised Repairer location will be provided. If the breakdown occurs more than 200 kilometres away from the nearest Authorised Repairer location, or, if the nearest Authorised Repairer location is not reachable, the vehicle will be towed to the nearest repair facility authorised by Roadside Assistance.

When the breakdown occurs in the town where the vehicle was originally sold, the vehicle should, at the beneficiary's discretion, be towed to the selling outlet for repair.

9. **Car Rental**

If in case of a breakdown, roadside repair is not possible and after towage of the vehicle to the Authorised Repairer location the repair cannot be completed within two hours of the arrival at the Authorised Repairer location, the Assistance Centre will approve and arrange for a rental car to be provided during the duration of the repair up to a maximum of 15 calendar days. Fuel costs, insurance deductible are at the expense of the beneficiary. Maximum category D, preference will be given to brands of the GM group.

10. **Onward/Homeward Travel**

If in case of a breakdown, roadside repair is not possible and after Assistance Centre-approved towage of the vehicle to the Authorised Repairer location the repair cannot be completed during the day of the breakdown, travel for the beneficiaries will

be reimbursed. This would entail reimbursement of the cost of First Class train ticket(s), or in the event that travel exceeds six hours, the cost of Economy Class flight ticket(s) for onward travel to the proven original destination or homeward travel, up to a maximum of EURO 613 per beneficiary (VAT included).

11. **Hotel**

If the breakdown occurs 80 or more kilometres from home, roadside repair is not possible and after towage of the vehicle to the Authorised Repairer location the repair cannot be completed during the day of the breakdown, three star or equivalent hotel accommodation will be arranged by the Assistance Centre for the beneficiaries during the duration of the repair up to a maximum of four nights.

12. Combination of Benefits under Items 10, 11, and 12

The benefits listed under Items 10, 11 and 12 may be combined. However, it is recognised that in certain circumstances, these services may have to be combined and common sense judgments should prevail (e.g., one-night accommodation upon incident late at night, where no onward travel/replacement car services can be arranged).

13. Vehicle Collection

Upon repair of the vehicle after a breakdown, the Assistance Centre will reimburse a First Class train ticket, or in the event that travel exceeds six hours, the cost of an Economy Class flight ticket, to the driver/owner or appointed representative (one person/one way only) for collecting the repaired vehicle from the place of repair up to a maximum cost of EURO 613 (VAT included).

As an alternative and up to the travel cost with a maximum of the agreed cost in this article, if the place of repair is more than 80 kilometres from beneficiary's home address, the Assistance Centre can approve the repatriation costs to the beneficiary's home address.

14. Spare Parts Dispatch

If breakdown occurs abroad and the necessary parts are not available through the Authorised Repairer in the country where the incident occurred, arrangement of dispatch and customs clearance formalities and transportation costs, excluding custom duties, for spare parts to the Authorised Repairer will be provided.

The costs of the spare parts will be borne by the Authorised Repairer if covered by the warranty, or by the beneficiary if not covered by the warranty

15. Services in Case of Accident, Theft, or Vandalism

In the case of accident, theft, or vandalism, organization of the services described above will be provided, only; costs for the services will be borne by the beneficiaries

16. List of Emergency Contact Telephone Numbers

36 Owner Assistance

Country	Local Phone Number	International Phone Number
Andorra	+34-900-151 886	+34-900-151 886
Austria	0800-20 19 10	+43-1-25 119 19399
Belgium	0800-14 134	+32 2 233 22 90
Bosnia and Herzegovina	(033)-282 102	+387-33-282-102
Bulgaria	(02)-986 73 52	+359-2-986 73 52
Croatia	0800-79 87	+385-1-464 01 41
Cyprus	22 31 31 31	+357-22-31 31 31
Czech Republic	261-10 43 48	+420-2-61 10 43 48
Denmark	80 20 22 07	+45-80 20 22 07
Estonia	(0)-69 79 199	+372-69 79 199
Finland	(09)-77 47 64 00	+358-9-77476400
France (+Corsica)	0800-25 66 59	+33-4-72 17 12 81
Germany	0800-22 34 552	+49-89-76 76 48 70
Gibraltar	900-151 886	+34-900-151 886
Greece	(210)-606 88 13	+30-210-60 68 813
Hungary	(06-1) 345 17 47	+36-1-345 17 47
Ireland	1800-304 500	+353-1-617 95 61

Country	Local Phone Number	International Phone Number
Italy (+Sicily/Sardinia/San Marino/ Vatican City)	800-836-056	+39-02-66 16 55 23
Latvia	67 56 65 86	+371-67 56 65 86
Lithuania	(85)-210 44 25	+370-5-210 44 25
Luxembourg	25 36 36 301	+352-25 36 36 301
Malta	21 24 69 68	+356-21 24 69 68
Monaco	+33-4-72 17 12 81	+33-4-72 17 12 81
Netherlands	0800-099 11 20	+31-70-314 51 12
Norway	800-30 466	+47-800-30 466
Poland	061 83 19 885	+48 61 83 19 885
Portugal	800-20 66 68	+351-21-942 91 05
Romania	021-317 46 90	+40-21-317 46 90
Russia	88002501218	+7-495-646 34 93
Serbia	(011)-240 43 51	+381-11-240 43 51
Slovakia	(02)-492 05 963	+421-2-49 20 59 63
Slovenia	(01)-530 53 10	+386-1-530 53 10
Spain	900-151 886	+34-900 151886
Sweden	020-78 77 88	+46-771-78 77 88

38 Owner Assistance

Country	Local Phone Number	International Phone Number
Switzerland (+Liechtenstein)	0800-55 19 46	+41-58-827 61 06
Turkey	(216) 560 07 50	+90 216 560 07 50
U.K.	0800-072 4791 or 00800-33 22 88 77	00800-33 22 88 77

**Notification of new Owner / Cadillac National Sales
Company copy**

Cadillac model

Vehicle Identification No. (V.I.N.)

Registration

Date of purchase

Mileage on purchase

New Owner's name initial(s) surname
Mrs / Ms / Miss / Mr *

Address Street
House no.
Postcode
Town

Telephone Private
Work

E-mail address

I voluntarily agree to the fact that my personal details will be stored in the Cadillac - GM database owned by (Chevrolet Europe GmbH) and processed for sale, aftersales service and marketing purposes related to the above and the driver's magazine other information will be sent to me. (please tick the box)

**Notification of new Owner / Cadillac National Sales
Company copy**

Cadillac model

Vehicle Identification No. (V.I.N.)

Registration

Date of purchase

Mileage on purchase

New Owner's name initial(s) surname
Mrs / Ms / Miss / Mr *

Address Street
House no.
Postcode
Town

Telephone Private
Work

E-mail address

I voluntarily agree to the fact that my personal details will be stored in the Cadillac - GM database owned by (Chevrolet Europe GmbH) and processed for sale, aftersales service and marketing purposes related to the above and the driver's magazine other information will be sent to me. (please tick the box)

 **NOTES**

 **NOTES**

 **NOTES**